



Suspended



Surface Mount

Product Features

Aeris Series - Ring shaped versatile architectural luminaire housing from aluminum extruded profile; available with standard matte black, matte white, or custom RAL finish; available with 5FT steel cable suspension system through surface canopy or direct ceiling mount; power supply unit to be installed in canopy or remote; entire luminaire homogeneously illuminated, with Anti-UV PMMA lens; SAMSUNG LED with above 90CRI; available in 3000K, 3500K, and 4000K, 70% of luminous flux after 50000 hours; ETL damp location listed; universal power supply with 0-10V dimming capability.

Technical Specifications

INPUT VOLTAGE	Universal Input AC120-277V
FREQUENCY	50/60hz
COLOR TEMPERATURE	3000K, 3500K, 4000K
COLOR RENDERING INDEX	90
DISTRIBUTION	Direct
IP RATING	Damp Location
LIFE SPAN	50,000 Hours
DIMMING	0-10V Dimming, Non-Dimmable



AERIS SERIES | AE**SUBMITTAL WORKSHEET**

Order Code Example: **AE** - **R1.5** - **940** - **QM** - **MB** - **blank**
 A **B** **C** **D** **E** **F**

A SERIES (CHOOSE ONE)

AE Aeris Series Ring Shaped Luminaire

B SIZE & OUTPUT (CHOOSE ONE)

CODE	POWER & LUMEN	LPW	DIMENSION	SUSPENSION	DRIVER	SECTION
R1.2 QS	15W 1,275lm	85	D14.2" x H3.5"	3	1	1
R1.5 QS	25W 2,125lm	85	D17.7" x H3.5"	3	1	1
R2 QS	36W 3,600lm	85	D23.6" x H3.5"	3	1	1
R2.6 QS	50W 4,250lm	85	D31.5" x H3.5"	3	1	1

C CCT (CHOOSE ONE)

930 90CRI, 3000K
935 90CRI, 3500K
940 90CRI, 4000K

D MOUNTING

CMPOS **QS** 5Ft Power over Suspension Cable, 10-inch Round Canopy
SM **QS** Surface Mount Kit, Remote Driver Enclosure

E FINISH

MB Matte Black
MW Matte White
MS Matte Silver
CC Customized Color

*see Customized Color Chart on Pg 3

F OPTIONS

blank 120-277V, 0-10V Dimming
FAD Customized Output (Consult Factory)
BAA Assembled in America, Compliant with BAA (COTS)

AERIS SERIES | AE

DIMENSIONS

AERIS - Quick Mount

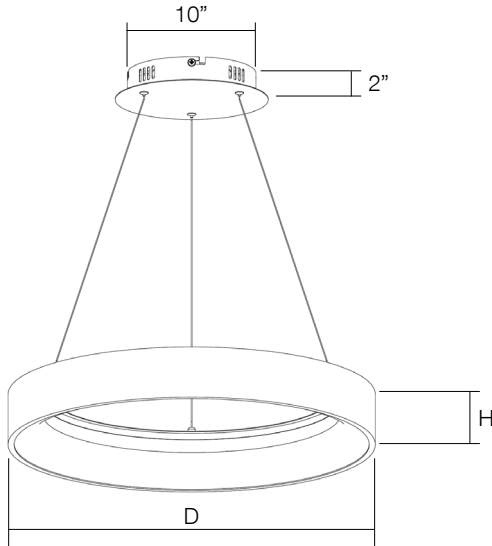

FIXTURE MODEL	DIMENSION
AE-R1.2	D14.2" x H3.5"
AE-R1.5	D17.7" x H3.5"
AE-R2	D23.6" x H3.5"
AE-R2.6	D31.5" x H3.5"

D = Outer Diameter

AERIS - Surface Mount

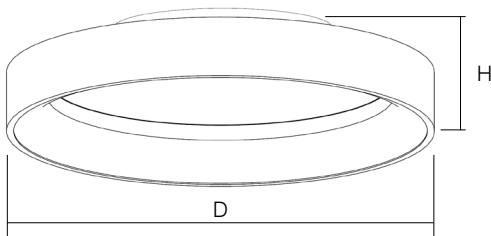





















FIXTURE MODEL	DIMENSION
AE-R1.2	D14.2" x H4.6"
AE-R1.5	D17.7" x H4.6"
AE-R2	D23.6" x H4.6"
AE-R2.6	D31.5" x H4.6"

D = Outer Diameter

COLOR CHART (CHOOSE ONE)

CC
RAL

Specify Color Code:
Specify RAL Color:

 GR - Green	 BL - Blue	 PP - Purple	 PK - Pink	 RD - Red	 OG - Orange	 YW - Yellow
 MB - Matte Black	 GB - Gloss Black	 MW - Matte White	 GW - Gloss White	 OB - Oil Rubbed Bronze	 GZ - Gloss Bronze	 MS - Matte Silver
 MBS - Matte Brass	 GBS - Gloss Brass	 CNH285 - American Walnut	 QL0928 - European Cherry	 QL0503 - Light Oak	 QL0411 - Maple	 QL0908 - Palisander Santos

AERIS SERIES | AE

PHOTOMETRIC

IES: AE-2 D-100% @ 36W

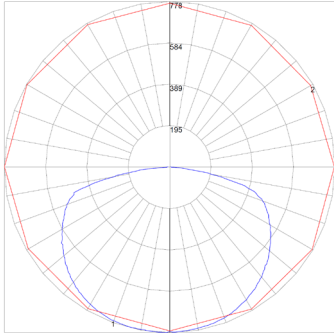

Zone	Lumen	Luminaire%
0-30	633	20.10
0-40	1077	34.20
0-60	2116	67.20
0-90	3149	100
0-180	3149	100

Lumen: 3149
 Input Watts: 36.08 W
 Efficacy: 87 LPW

INSTALLATION

Quick Mount Installation

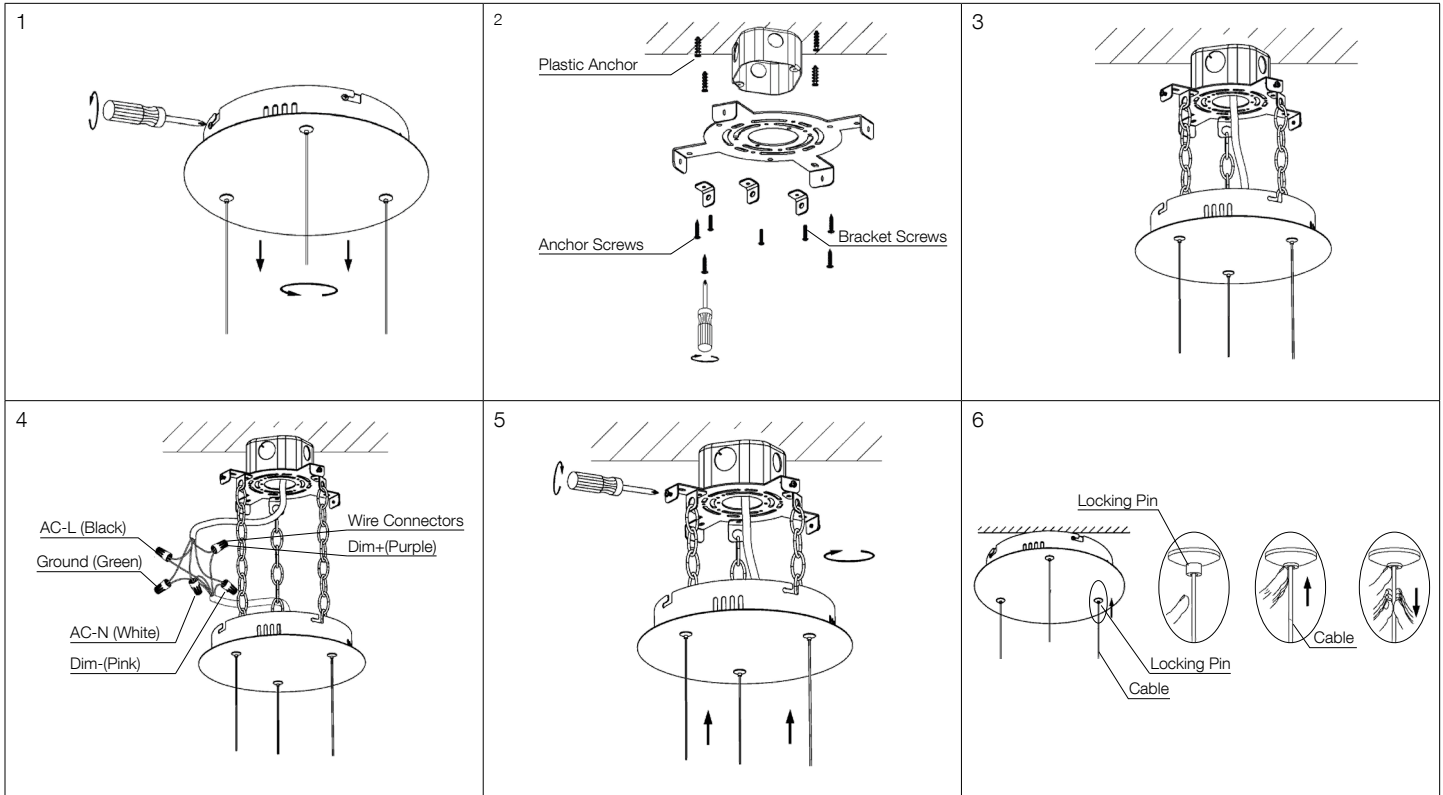

Step 1: Use Screw driver to relief the Screws between Mounting Canopy and Bracket from side.

Step 2: Remove Plastic Anchors. Drill seven $\varnothing 6$ mm ceiling holes according to the Mounting Bracket (4 for Bracket Screws, 3 for Safety Bracket Screws). Insert Plastic Anchors. Secure Mounting Bracket to J-Box using two M4 \times 25 mm Bracket Screws.
Note: J-Box: Garvin 54171-S or equivalent; Bracket Screws by others.

Step 3: Use 4pcs M4 \times 25 Self-Tapping Anchor Screws to fix Mounting Bracket on the ceiling.

Step 4: Use wire connectors to connect L,N,G,DIM+,DIM- wires. After finish, put all wires with connector into J-Box.

Step 5: Use Screw driver to adjust Mounting Bracket and Mounting Canopy.

Step 6: Adjust the fixture safety cable and Aircraft cable length. Then loosen all the cables to finish installation.

INSTALLATION

Surface Mount Installation

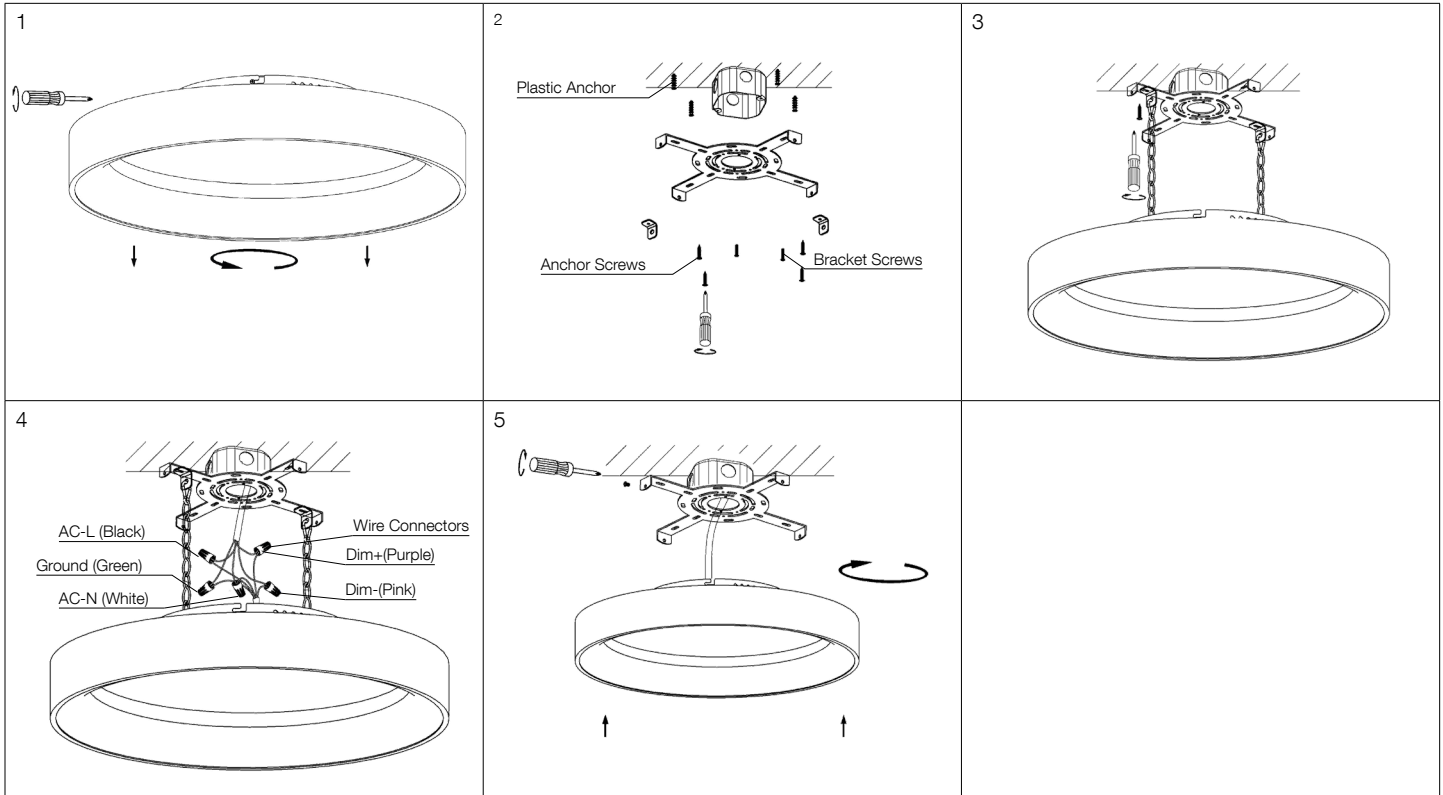

Step 1: Rotate Canopy and take it out from Bottom Bracket as below.

Step 2: Remove Plastic Anchors. Drill four or six $\phi 6$ mm ceiling holes per Mounting Bracket (six holes if fixture diameter is $\geq 24"$).
Insert Plastic Anchors. Secure Mounting Bracket to J-Box using two M4 \times 25 mm Bracket Screws.
Note: J-Box: Garvin 54171-S or equivalent; Bracket Screws by others.

Step 3: Use 4pcs M4 \times 25 Self-Tapping Anchor Screws to fix Mounting Bracket on the ceiling.

Step 4: Use wire connectors to connect L,N,G,DIM+,DIM- wires. After finish, put all wires with connector into J-Box.

Step 5: Keep the Slot hole as vertical line with Side screw, and make screw into slot, then rotate lamp body to secure and finish installation.