



Product Features

LUX Series LX2.3P architectural regressed linear luminaire constructed from a 2.3" wide extruded aluminum profile. Available in 2, 3, and 4-foot lengths with continuous-run capability. Features an integral 120–277V driver with 0-10V dimming, frosted polycarbonate lens, and direct light distribution. LED source provides field-selectable wattage and CCT options of 3000K / 3500K / 4000K with >80 CRI. Rated for damp locations, cULus listed, and designed for a minimum L70 of 50,000 hours.

Technical Specifications

INPUT VOLTAGE	Universal Input AC120-277V
FREQUENCY	50/60hz
COLOR TEMPERATURE	Field Selectable 3000K / 3500K / 4000K
COLOR RENDERING INDEX	>80
DISTRIBUTION	Direct, Field Selectable Output
IP RATING	Damp Location
LIFE SPAN	>50,000 Hours
DIMMING	0-10V Dimming



LUX SERIES | LX2.3P PERIMETER REGRESSED LINEAR

SUBMITTAL WORKSHEET

Order Code Example: LX2.3-CON

H

H OPTIONS

LX2.3-CON	QS	LUX 2.3" Profile Line Joiner (metal bracket)
LX2.3P-CON-IN*	QS	LUX 2.3" Perimeter 90° Illuminated Inside Corner
LX2.3P-CON-OUT*	QS	LUX 2.3" Perimeter 90° Illuminated Outside Corner

*see page 5 for detail.

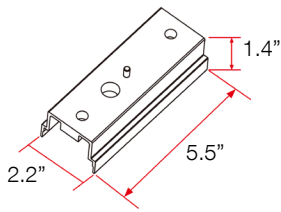

LX2.3-CON
LUX 2.3" Profile Line Joiner
(metal bracket)

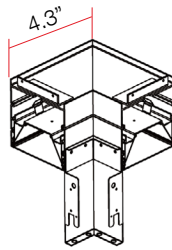

LX2.3P-CON-IN
LUX 2.3" Perimeter 90°
Illuminated Inside Corner

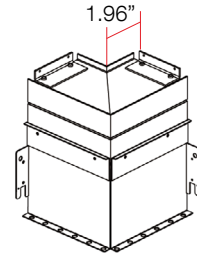

LX2.3P-CON-OUT
LUX 2.3" Perimeter 90°
Illuminated Outside Corner

LUX SERIES | LX2.3P PERIMETER REGRESSED LINEAR

DIMENSIONS

SERIES & SIZE	DIMENSION	Section
LX2.3P-R2	L23.51" x W2.34" x H3.46"	1
LX2.3P-R3	L35.52" x W2.34" x H3.46"	1
LX2.3P-R4	L47.52" x W2.34" x H3.46"	1

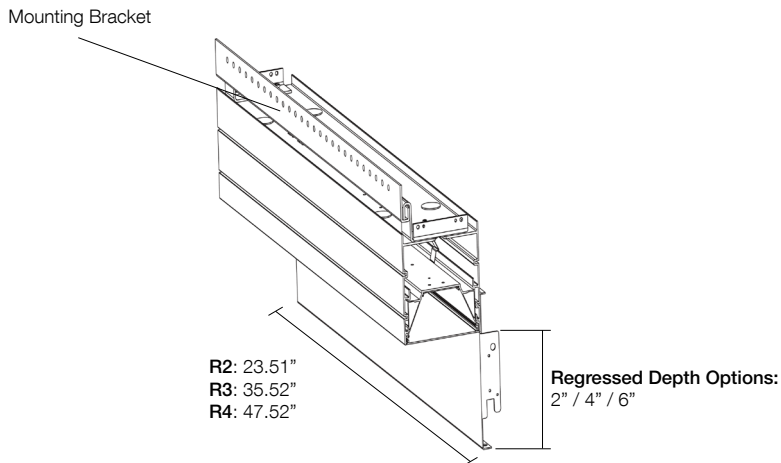

End Caps

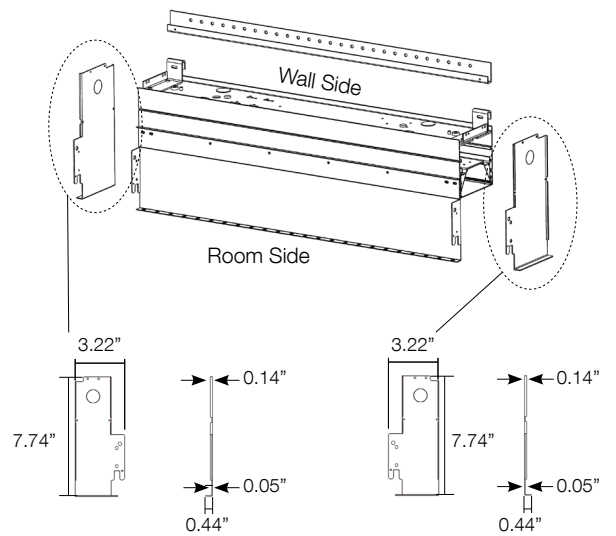

CONTINUOUS RUN

Continuous Run

Seamless joining system for field assembly.
Single power feed supports multiple lamps.

120VAC: Connections up to 40ft.
277VAC: Connections up to 100ft.

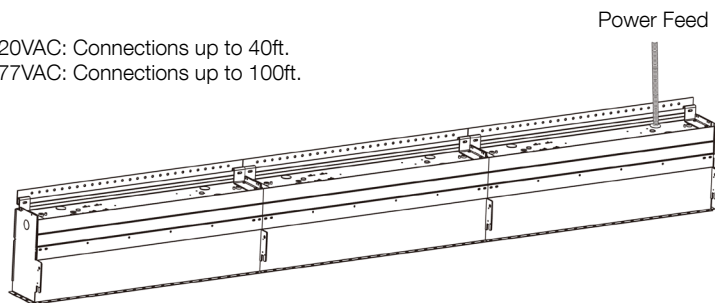

Total Length of Each Run	Run Configuration
8FT	4FT + 4FT
9FT	4FT + 3FT + 2FT
10FT	4FT + 4FT + 2FT
11FT	4FT + 4FT + 3FT
12FT	4FT + 4FT + 4FT

LUX SERIES | LX2.3P PERIMETER REGRESSED LINEAR

CORNERS

Optional Pre-Built 90° Corners

Patterns are customizable with illuminated 90° inside or outside corners, using standard 2' corner junction lengths. These fully illuminated, factory-built corners ship in a single all-in-one box for easy, streamlined installation.

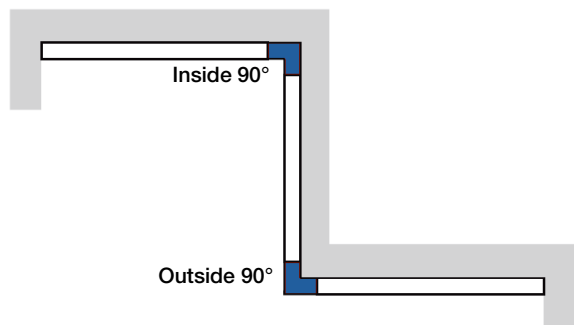

Inside Corner

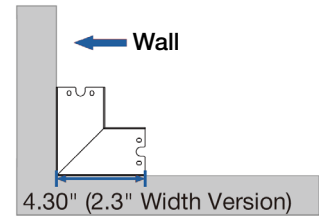
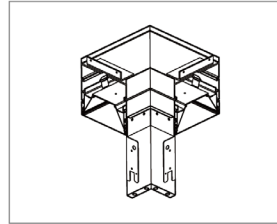

Outside Corner

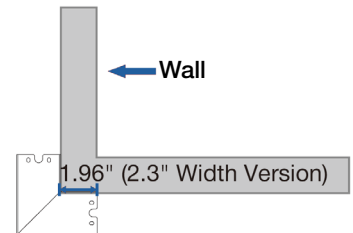
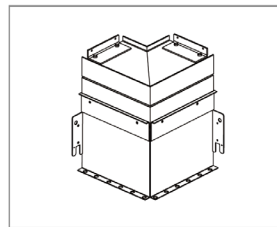

TELESCOPING SECTION

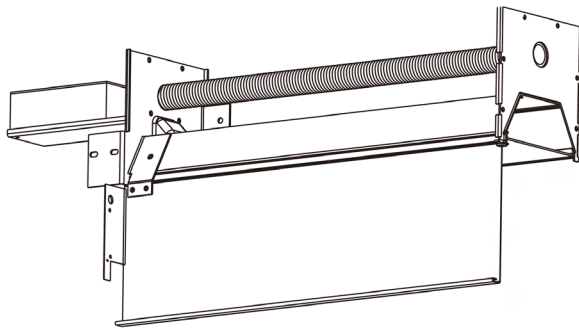

2FT + Telescoping Section + 2FT

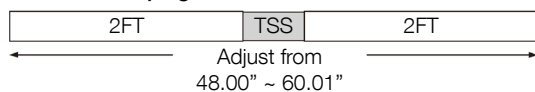

2FT + Telescoping Section + 3FT

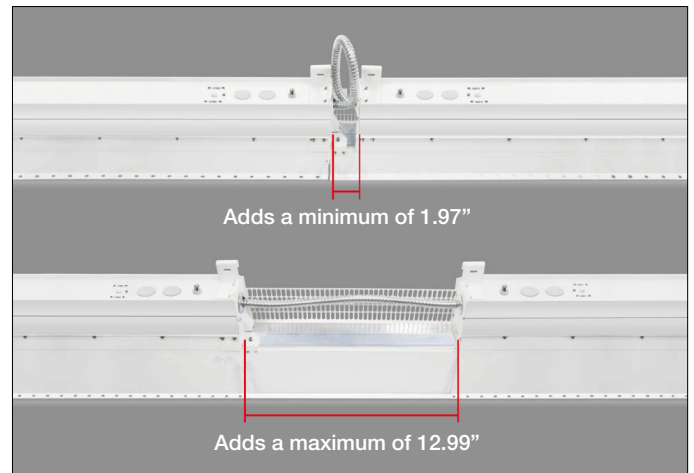
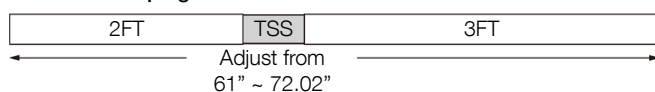

LUX SERIES | LX2.3P PERIMETER REGRESSED LINEAR

EMB SPEC

Model	Battery Capacity	Input	Output	Output Power	Operating Temp	Installation
EMB-8W-B	90mins	100-347VAC	170VDC	8W	0°C ~ 50°C 32°F ~ 122°F	Factory or Field Install
EMB-18W-B	90mins	100-347VAC	170VDC	18W	0°C ~ 50°C 32°F ~ 122°F	Factory or Field Install

