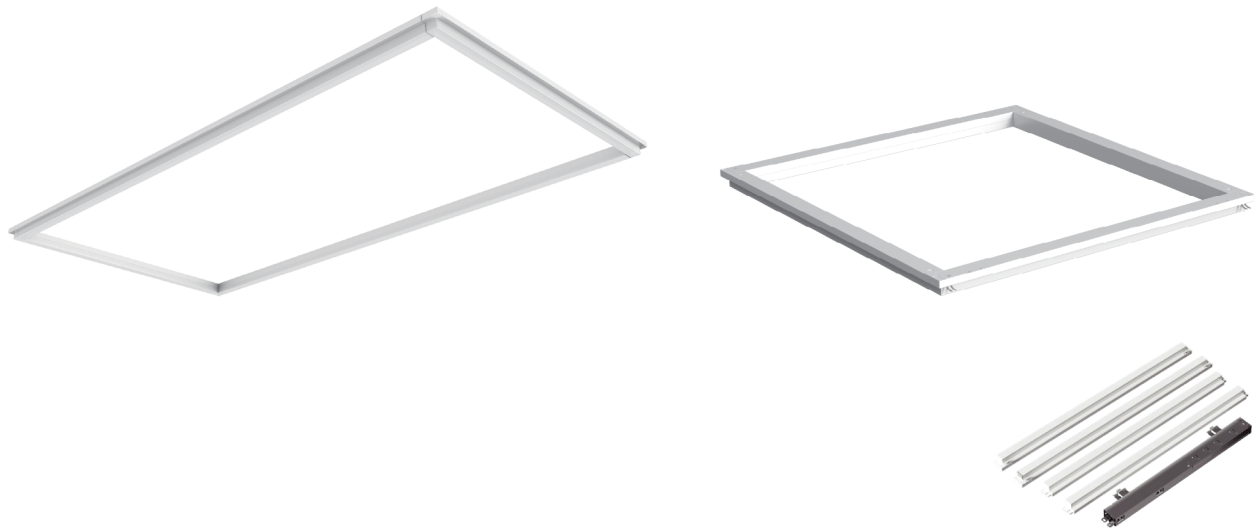

FRAME SERIES | ARCHITECTURAL T-GRID FRAME LUMINAIRE

Product Features

Frame Gen 2 Series - Architectural T-Grid luminaire completely transforms the monotonous grid ceiling into a contemporary lighting statement. Designed for lay-in T-Grid applications and available in 1FT by 4FT, 2FT by 2FT, and 2FT by 4FT configurations. Features field selectable CCT from 2,700~5000K, a universal driver for 120-277V input and 0-10V dimming. Constructed with an aluminum heatsink for superior thermal management and long-term reliability. Precision optics provide smooth, even illumination without hot spots. >90CRI; >100,000 hours; cULus damp location listed.

Technical Specifications

INPUT VOLTAGE	AC120-277V
FREQUENCY	50/60hz
LUMEN	1x4 & 2x2: 2500~5000LM 2x4: 3800~6400LM
WATTAGE	Field Selectable 1x4 & 2x2: 20/30/40W 2x4: 30/40/50W
LPW	136
COLOR TEMPERATURE	Field Selectable: 2700K, 3000K, 3500K, 4000K, 5000K
COLOR RENDERING INDEX	>90
DISTRIBUTION	120°
IP RATING	Damp Location
LIFE SPAN	>100,000 Hours
DIMMING	0-10V, 10-100% Dimming



FRAME SERIES | ARCHITECTURAL T-GRID FRAME LUMINAIRE

SUBMITTAL WORKSHEET

Order Code Example: LUMINAIRE

GF-G2 - 22 - 9SC - WH - UD

A B C D E

Order Code Example: OPTIONS

EMB-H08170

F

A SERIES (CHOOSE ONE)

GF-G2 Architectural T-Grid Frame - Gen 2

B LIGHT ENGINE (CHOOSE ONE)

CODE		POWER	TYPE	MOUNTING	LUMEN
14	QS	Field Selectable 20/30/40W	1x4	Lay-in	2,500 ~ 5,500LM
22	QS	Field Selectable 20/30/40W	2x2	Lay-in	2,500 ~ 5,500LM
24	QS	Field Selectable 30/40/50W	2x4	Lay-in	3,800 ~ 6,500LM

C CCT (CHOOSE ONE)

9SC QS 90 CRI Field Selectable 2700/3000/3500/4000/5000K

D FINISH (CHOOSE ONE)

WH QS White

E POWER

UD QS Universal 120-277V Input, 0-10V 10-100% Dimmable Driver

F OPTIONS

BAA Assembled in America, Compliant with BAA (COTS)

EMB-H08170 QS 90-Minute Self-Diagnostic Emergency Battery 8W 100-347VAC Input 170VDC Output

EMB-H18170 QS 90-Minute Self-Diagnostic Emergency Battery 18W 100-347VAC Input 170VDC Output

FRAME SERIES | ARCHITECTURAL T-GRID FRAME LUMINAIRE

DIMENSIONS

LUMINAIRE CODE	L	W	H
GF-G2-14	47.8"	12"	1"
GF-G2-22	23.8"	23.8"	1"
GF-G2-24	47.8"	23.8"	1"

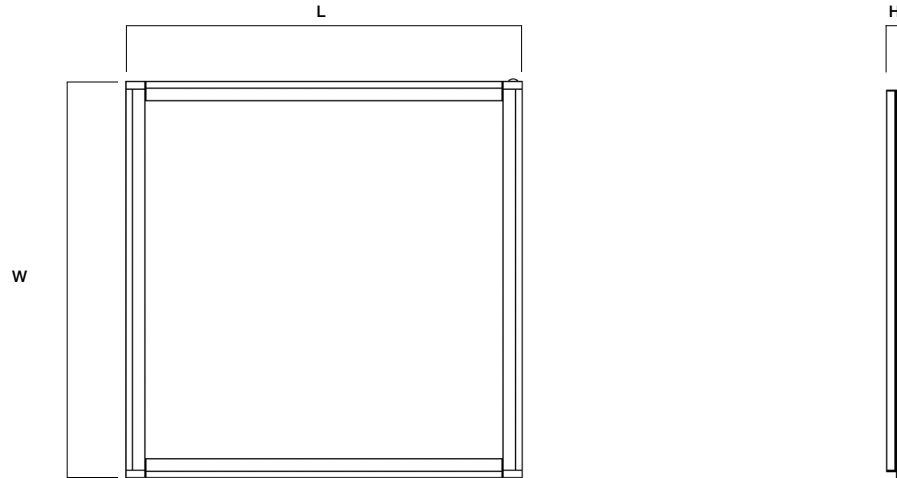

OUTPUT

CCT and Wattage Selectable

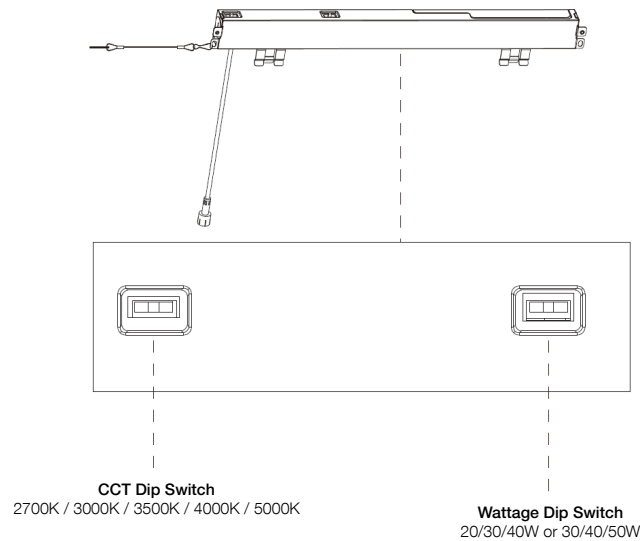

FRAME SERIES | ARCHITECTURAL T-GRID FRAME LUMINAIRE

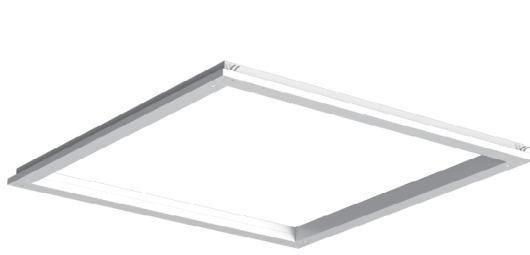

GF-G2-14 / 22 / 24 Luminaire Summary

Power: GF-G2-14/-22: Field Selectable 20/30/40W, GF-G2-24: Field Selectable 30/40/50W

Quality: 90 CRI

CCT: Field Selectable 2700K / 3000K / 3500K / 4000K / 5000K

Input: 120~277V, 50/60Hz

Dimming: 0-10V 10-100% Dimming

Power Factor: Greater than 0.9

Ambient Operating Temperature: -20C° to 40°C (-4°F to 104°F)

Lifetime: 100,000 hours at 70% lumen maintenance

Listing: cULus, Damp Location

ELECTRICAL DATA

SIZE	NUMBER OF DRIVERS	DRIVER CURRENT (mA)	Nominal Power (W)	INPUT VOLTAGE (V)	CURRENT (AMPS)
GF-G2-14/-22	1	1100	40	120	0.33
			40	208	0.19
			40	240	0.17
			40	277	0.14
GF-G2-24	1	1270	50	120	0.42
			50	208	0.24
			50	240	0.21
			50	277	0.18

FRAME SERIES | ARCHITECTURAL T-GRID FRAME LUMINAIRE

PHOTOMETRIC

IES: GF-G2-22 @ 40W 3500K

IES: GF-G2-24 @ 50W 3500K

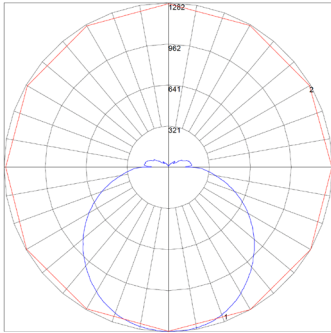

Zone	Lumen	Luminaire%
0-30	1014	19.70
0-40	1682	32.60
0-60	3111	60.40
0-90	4526	87.80
0-180	5154	100

Lumen: 5154.20
 Input Watts: 37.68 W
 Efficacy: 137 LPW

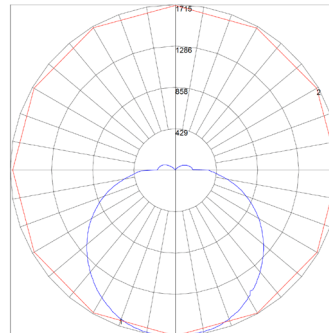

Zone	Lumen	Luminaire%
0-30	1354	20.70
0-40	2247	34.40
0-60	4160	63.70
0-90	6053	92.70
0-180	6530	100

Lumen: 6530.10
 Input Watts: 47.78 W
 Efficacy: 137 LPW

EMB SPEC

Model	Battery Capacity	Input	Output	Output Power	Operating Temp	Installation
EMB-H08170	90mins	100-347VAC	170VDC	8W	0°C ~ 50°C 32°F ~ 122°F	Field Install
EMB-H18170	90mins	100-347VAC	170VDC	18W	0°C ~ 50°C 32°F ~ 122°F	Field Install

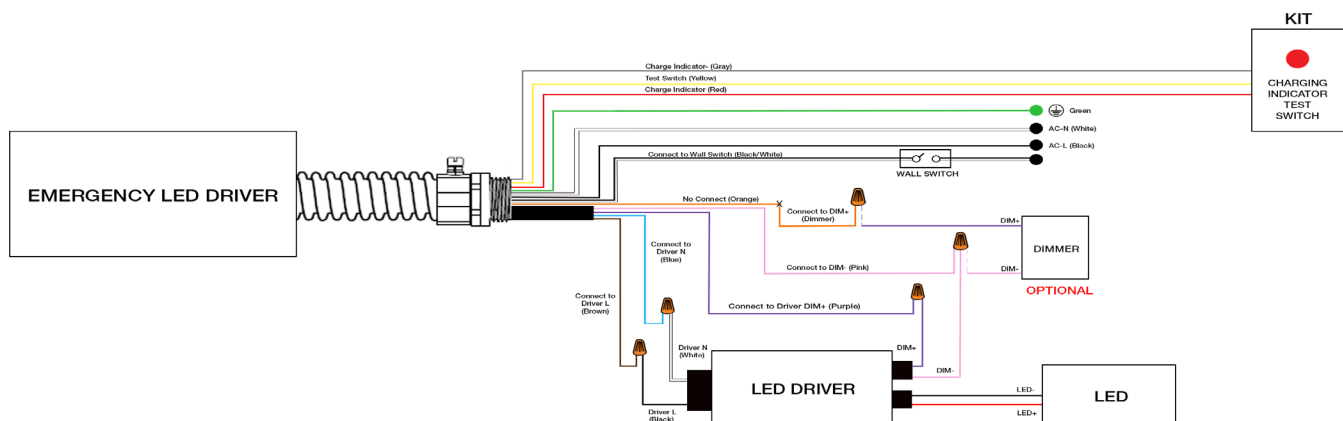

FRAME SERIES | ARCHITECTURAL T-GRID FRAME LUMINAIRE

INSTALLATION

T-Grid Recessed Mount Installation

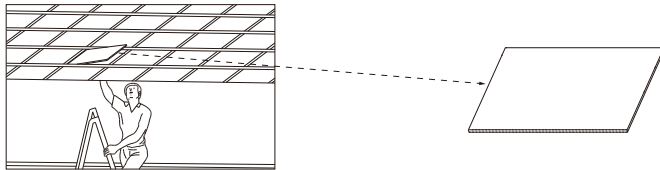

1. Turn off the main power switch first and take out the luminaire and driver.
2. Confirm the luminaire mounting position first, then remove the ceiling tile (retain the tile; do not discard it).

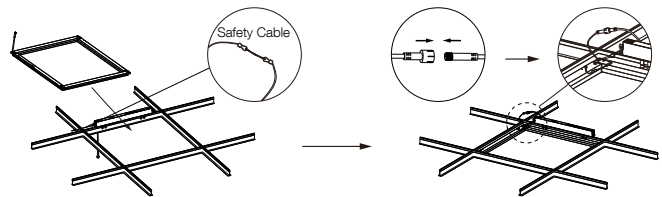

5. Place the luminaire on the T-Grid, fasten the safety cable on the luminaire to the one on the power supply, then connect the wires between the luminaire and the power supply.

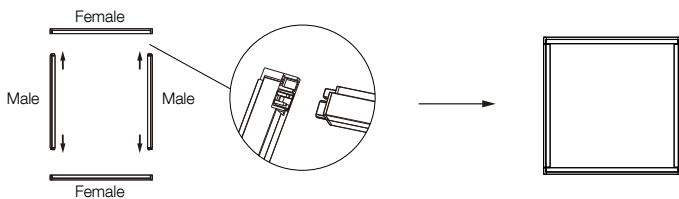

3. Identify the male and female connectors, then insert the male connector into the female connector to assemble the complete luminaire.

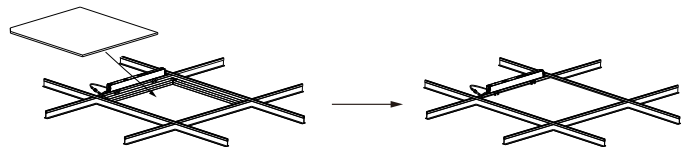

6. Replace the ceiling tile.

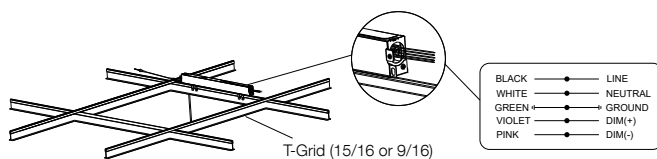

4. Snap the driver onto the T-Grid. Knock out the knockout hole on the power supply housing, then terminate the wiring to the driver in accordance with the wiring diagram.

FRAME SERIES | ARCHITECTURAL T-GRID FRAME LUMINAIRE

INSTALLATION

Emergency Power Supply Installation

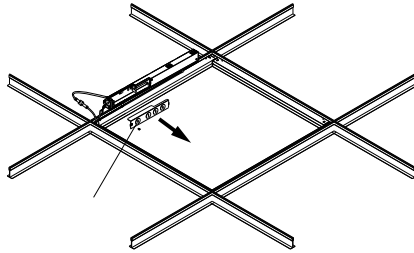

1. Remove the sheet metal cover from the driver and knock out the knockout hole.

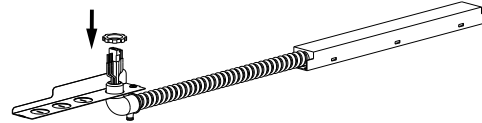

2. Remove the nut from the emergency power supply assembly, pass it through the hole in the sheet metal cover as shown in the diagram, then fasten the nut back.

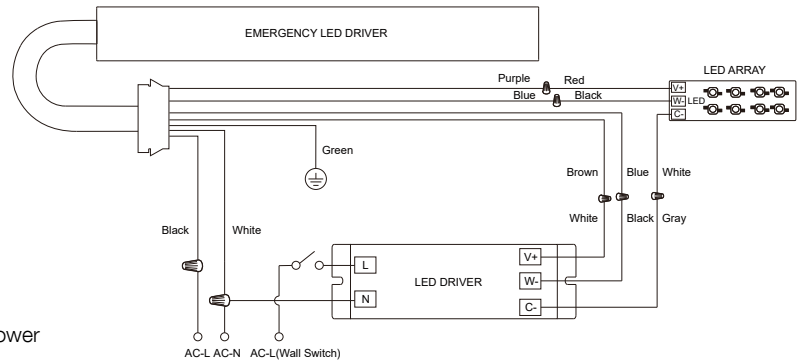

3. Connect the wires of the emergency power supply to the main power supply in accordance with the following diagram.

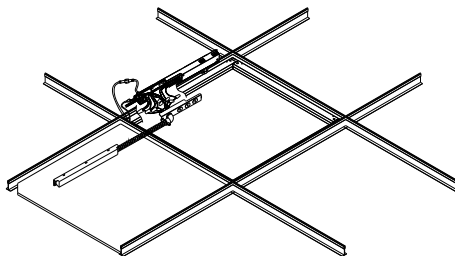

4. Reinstall the sheet metal cover together with the emergency power supply.

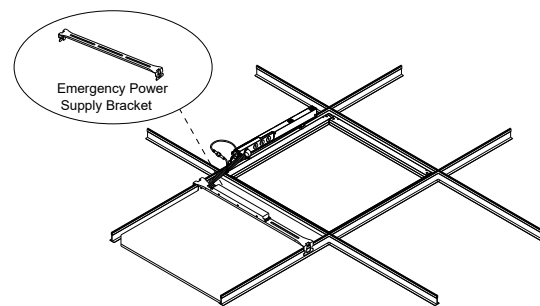

5. Snap the emergency power supply bracket onto the T-Grid and secure the emergency power supply to the bracket with the screws.

FRAME SERIES | ARCHITECTURAL T-GRID FRAME LUMINAIRE

INSTALLATION

PIR Sensor Installation

