

Product Features

The Lumina IP65 Wet-Rated linear luminaire is engineered for demanding environments, delivering flexible control, long-lasting performance, and high-quality illumination with wide, uniform coverage. Made with 3" aluminum housing, available in a 2, 4, and 8-FT increment with outdoor weather resistant Black or White finish options; high-transmission water tight polycarbonate lens; integral driver; wide 110° distribution; ≤5 SDCM color consistency >90CRI LED; field selectable CCT in 3000K / 3500K / 4000K; LED lifespan L₇₀ great than 100,000 hours; IP65 wet location listed; universal input 120-277VAC input voltage; 0-10V dimming with a 0-100% dimming range.

Technical Specifications

INPUT VOLTAGE	Universal Input 120-277 VAC
FREQUENCY	50/60hz
COLOR TEMPERATURE	Field Selectable 3000K / 3500K / 4000K
COLOR RENDERING INDEX	>90
DISTRIBUTION	Wide - 110°
IP RATING	IP65 Wet Rated
LIFE SPAN	L ₇₀ >100,000 Hours
DIMMING	0-10V Dimming, 0-100% Dimming Range



LUMINA SERIES | WET-RATED

SUBMITTAL WORKSHEET

Order Code Example: **LMA-W** - **L2** - **9SC** - **SM** - **BK** - **UD** - **OPTIONS**
 A **B** **C** **D** **E** **F** **G**

A SERIES

LMA-W Lumina Wet-Rated Architectural Linear

B SIZE & OUTPUT (CHOOSE ONE)

CODE	LENGTH	POWER & LUMEN FIELD SELECTABLE*	EFFICACY (AVG.)
L2	2FT	15W / 20W / 25W	112 lm/W 12.5 W/ft 1396 lm/ft
L4	4FT	30W / 40W / 50W	112 lm/W 12.5 W/ft 1396 lm/ft
L8	8FT	60W / 80W / 100W	112 lm/W 12.5 W/ft 1396 lm/ft

C CCT

8SC 80 CRI Field Selectable 3000K / 3500K / 4000K
9SC 90 CRI Field Selectable 3000K / 3500K / 4000K

D MOUNTING (CHOOSE ONE)

STM-2* 2FT Stem Pendant Mount
SM* Surface Mount Kit
WM* Wall Mount

*see page 3 for detail

E FINISH (CHOOSE ONE)

BK Black
WH White

D INPUT (CHOOSE ONE)

UD 120-277VAC, 0-10V Dimming, 0-100% Dimming Range

G OPTIONS

BAA Assembled in America, Compliant with BAA (COTS)
LMA-W-CON Waterproof jumper cable and metal bracket for straight run connection
EMB-8W-B** 90-Minute Self-Diagnostic Emergency Battery 8W 100-347VAC Input 170VDC Output

*see page 4 for detail

**see page 6 for EMB spec

LUMINA SERIES | WET-RATED

MOUNTING KITS

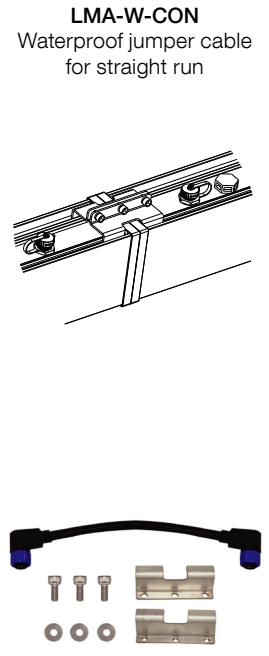
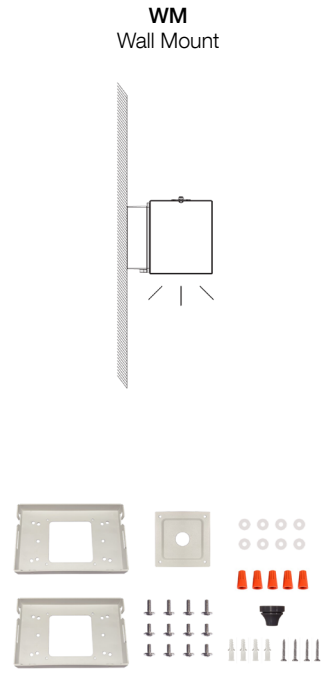
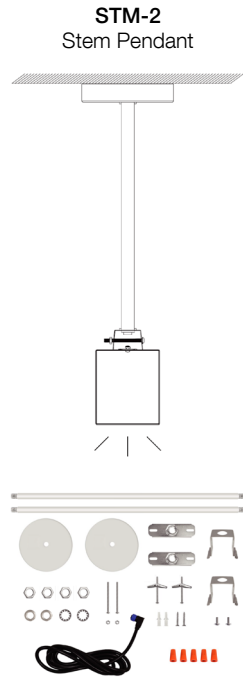

DIMENSIONS - FIXTURE

Size	L	W	H
2FT	24"	3.15"	3.70"
4FT	47.83"		
8FT	95.08"		

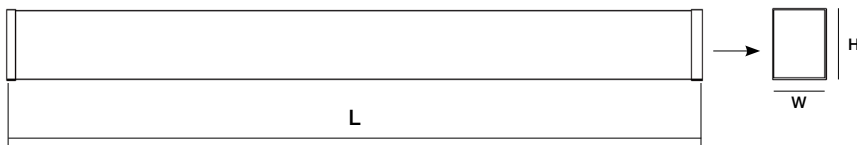

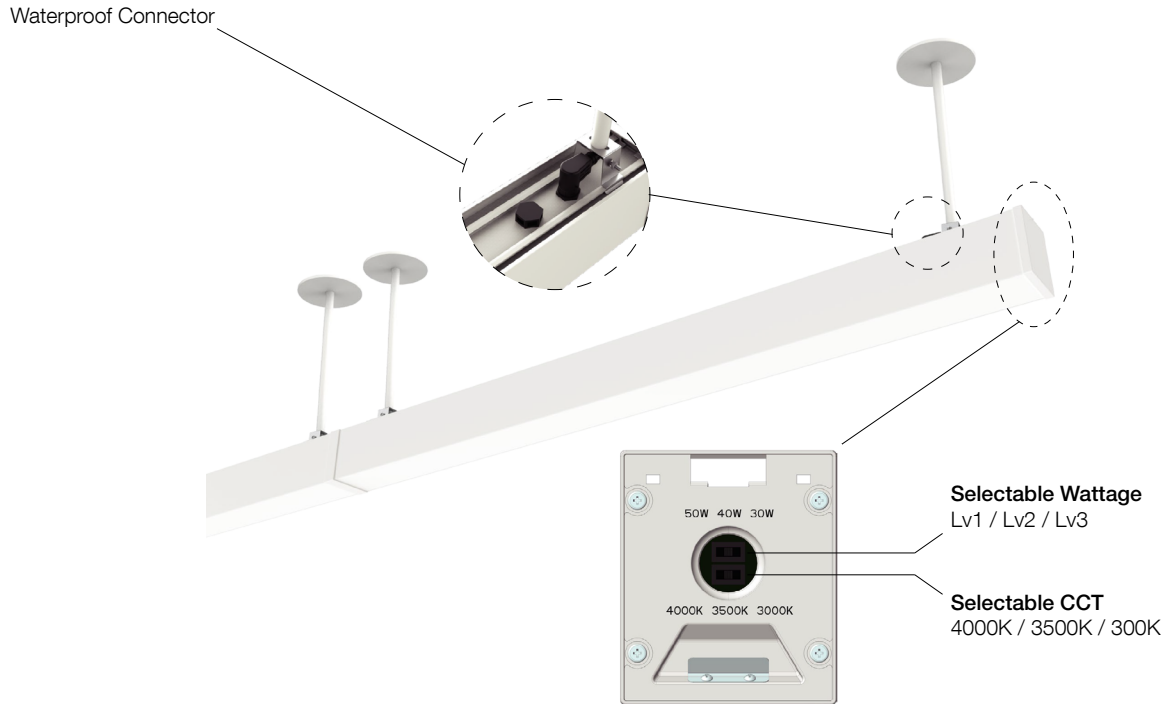
LUMINA SERIES | WET-RATED
OUTPUT

ELECTRICAL DATA

Number of Drivers	Size	Driver Current (mA)	Nominal Power (W)	Input Voltage (V)	CURRENT (AMPS)
1	2FT	525	25	120	0.21
			25	208	0.12
			25	240	0.10
			25	277	0.09
1	4FT	1050	50	120	0.42
			50	208	0.24
			50	240	0.21
			50	277	0.18
1	8FT	2100	100	120	0.83
			100	208	0.48
			100	240	0.42
			100	277	0.36

LUMINA SERIES | WET-RATED

PHOTOMETRIC

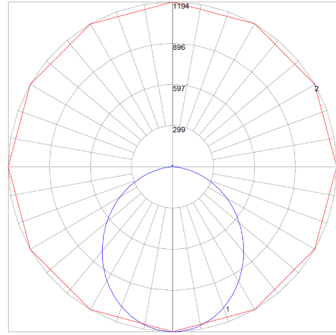
IES: LMA-W-L2 @ 4000K 25W



Zone	Lumen	Luminaire%
0-30	899	29.10
0-40	1446	46.90
0-60	2472	80.10
0-90	3056	99.00
0-180	3088	100

Lumen: 3088
Input Watts: 25 W
Efficacy: 123 LPW

IES: LMA-W-L4 @ 4000K 50W

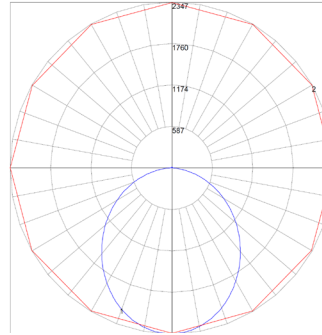

Zone	Lumen	Luminaire%
0-30	1775	28.60
0-40	2864	46.20
0-60	4936	79.60
0-90	6172	99.50
0-180	6204	100

Lumen: 6204
Input Watts: 50 W
Efficacy: 124 LPW

LUMINA SERIES | WET-RATED

EMB SPEC

Model	Battery Capacity	Input	Output	Output Power	Operating Temp	Installation
EMB-8W-B	90mins	100-347VAC	170VDC	8W	0°C ~ 50°C 32°F ~ 122°F	Field Install

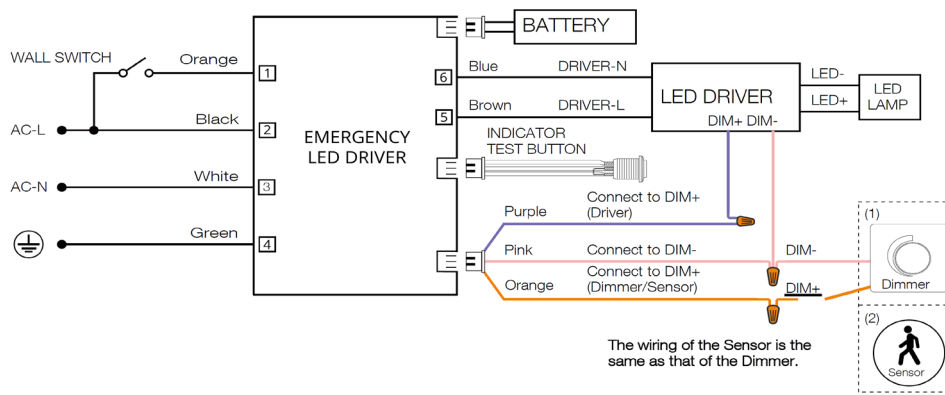

LUMINA SERIES | WET-RATED

INSTALLATION

CCT and Wattage Adjustment

Adjust the color temperature and wattage to the desired setting before beginning installation.

Ensure the cover and silicon ring are well installed before adjust the DIP switch.

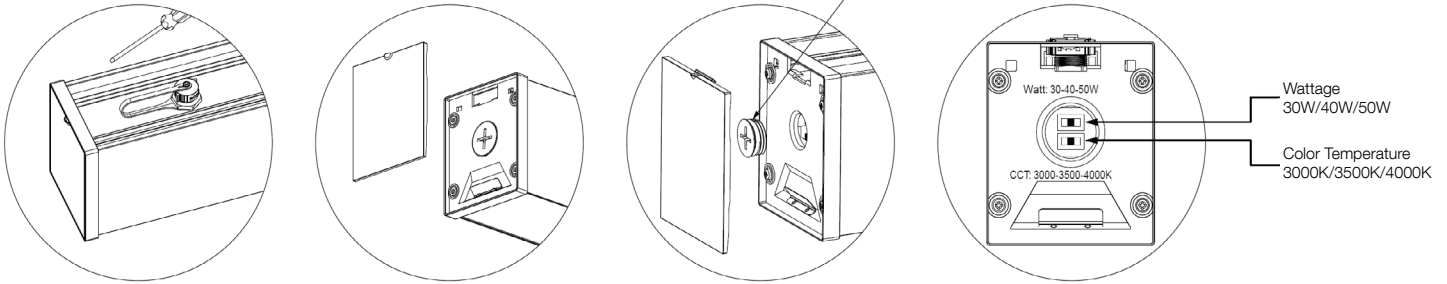

Multiple Fixtures Installation

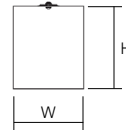
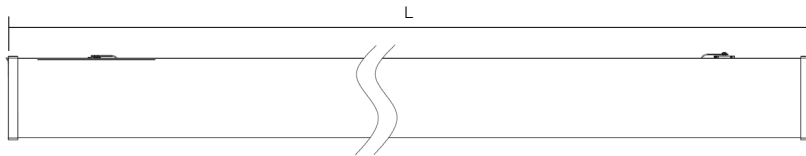

Size	L	W	H
4FT	47.83"	3.15"	3.70"
8FT	95.08"		

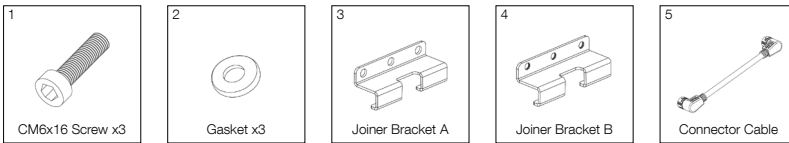

Fixture Connection

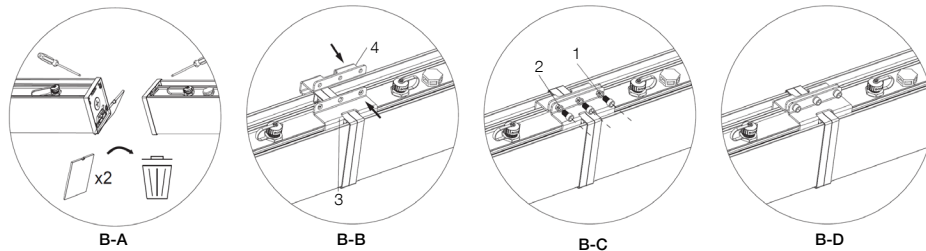

1. Remove the endcaps of the luminaires with a screwdriver. (B-A)
2. Push the joiner brackets straight into the luminaire body. (B-B)
3. Secure the two joiner brackets to each other with the gaskets and screws. (B-C)
4. See the installation completion diagram above. (B-D)

Electrical Connection

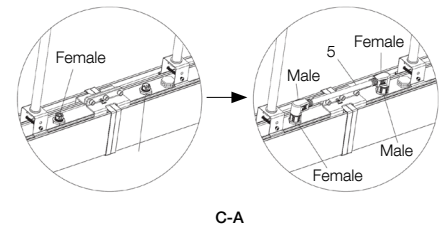

Connect the cable to the spliced fixture. Ensure proper connection of both ends as illustrated: male connector to female socket and female connector to male socket. (C-A)

LUMINA SERIES | WET-RATED

INSTALLATION

STM - Stem Mount Installation

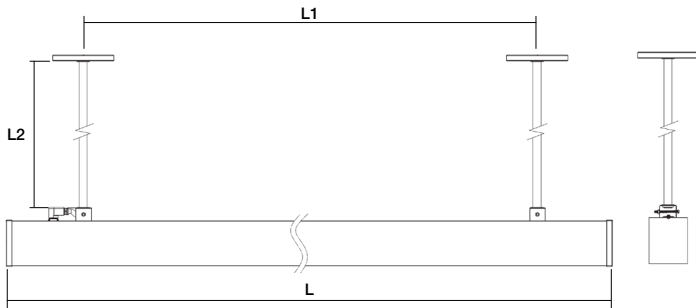

Size	L	L1	L2
4FT	47.83"	35"-40.98"	2'
8FT	95.08"	82.24"-88.23"	

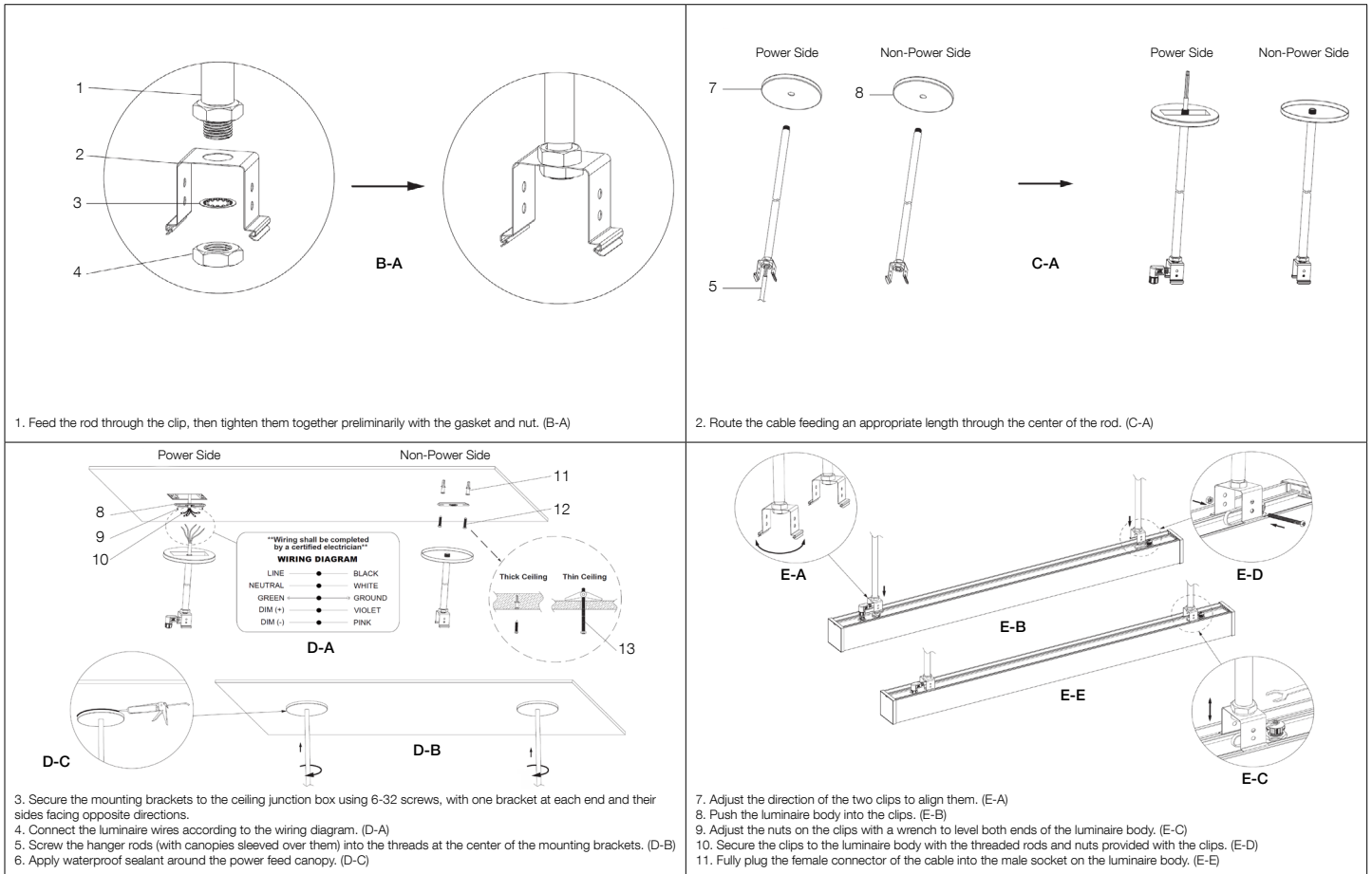
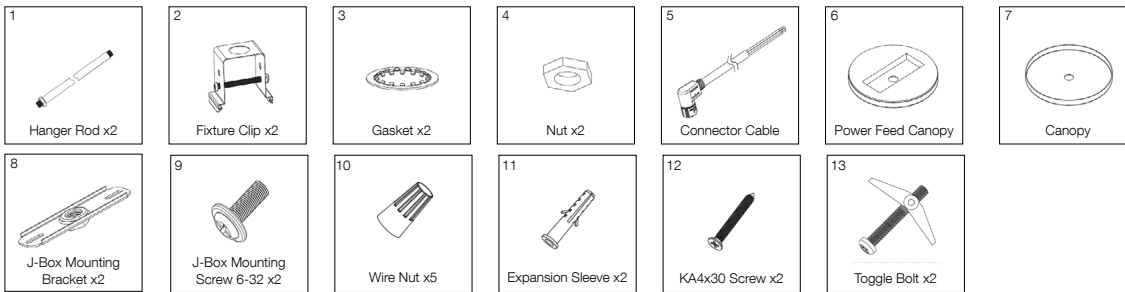

LUMINA SERIES | WET-RATED

INSTALLATION

SM - Surface Mount Installation

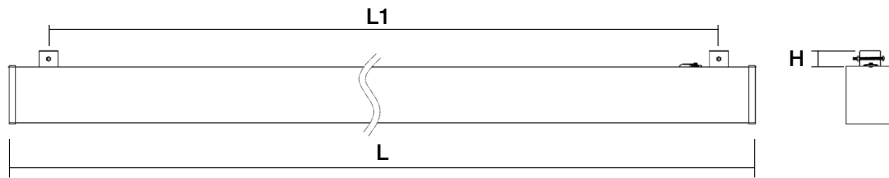

Size	L	L1	H
4FT	47.83"	35"-40.98"	1.13"
8FT	95.08"	82.24"-88.23"	

- 1



Ceiling Clip x2
- 2



Expansion Sleeve x4
- 3



KA4x30 Screw x4
- 4

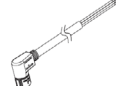

Connector Cable
- 5



Wire Nut x5
- 6



Toggle Bolt x4

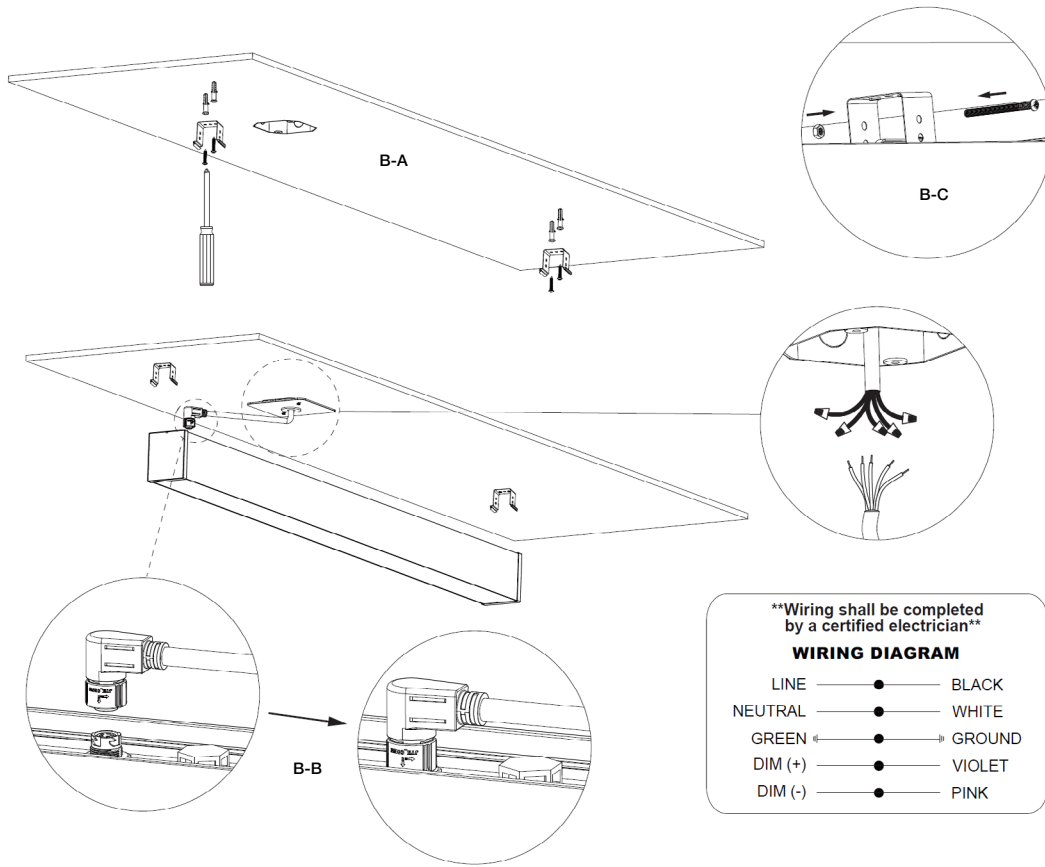

****Wiring shall be completed by a certified electrician****

WIRING DIAGRAM

LINE	●	BLACK
NEUTRAL	●	WHITE
GREEN	●	GROUND
DIM (+)	●	VIOLET
DIM (-)	●	PINK

1. Secure the clips to the ceiling with the expansion anchors (for thick ceilings) or toggle bolts (for thin ceilings). (B-A)
2. After the wires are properly connected, snap the luminaire body into the clips. (B-B)
3. Secure the clips with the threaded rods and nuts to complete installation. (B-C)

LUMINA SERIES | WET-RATED

INSTALLATION

WM - Wall Mount Installation

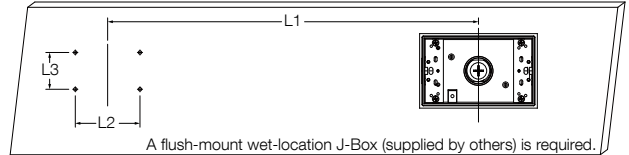
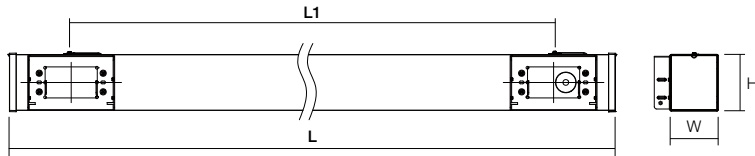

Size	L	L1	L2	L3	W	H
4FT	47.83"	40"	3.29"	1.87"	3.15"	3.72"
8FT	95.08"	87.24"				

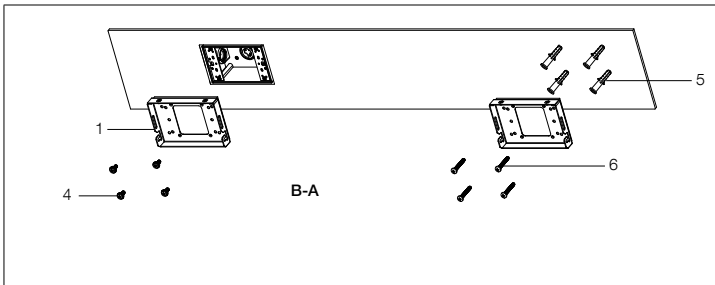
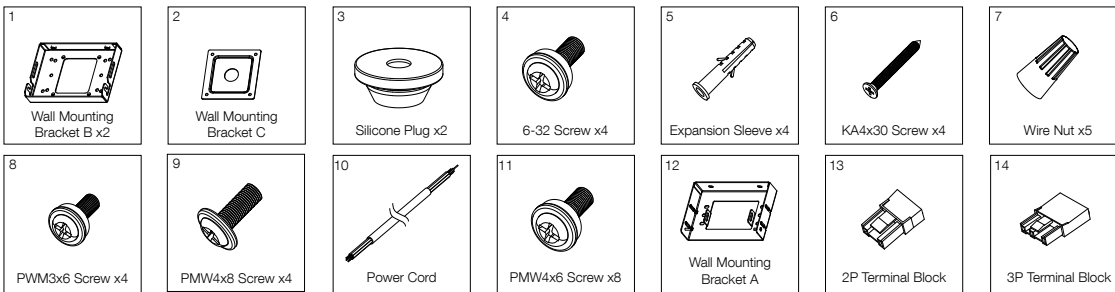
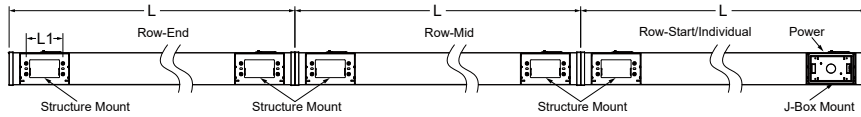

1. Mount bracket B on the power side at the appropriate location using 6-32 screws fitted with silicone O-rings.
2. Mount the second bracket B on the non-power side with the expansion anchors. (B-A)

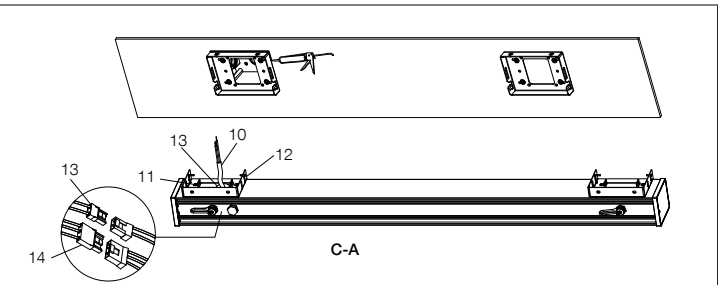

3. Apply waterproof sealant around bracket B on the power side. (C-A)

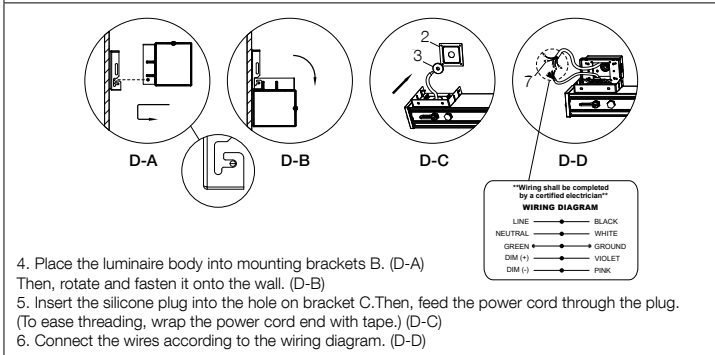

4. Place the luminaire body into mounting brackets B. (D-A) Then, rotate and fasten it onto the wall. (D-B)
5. Insert the silicone plug into the hole on bracket C. Then, feed the power cord through the plug. (To ease threading, wrap the power cord end with tape.) (D-C)
6. Connect the wires according to the wiring diagram. (D-D)

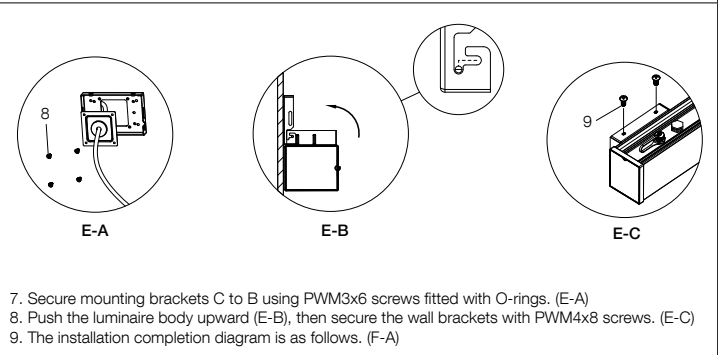

7. Secure mounting brackets C to B using PWM3x6 screws fitted with O-rings. (E-A)
8. Push the luminaire body upward (E-B), then secure the wall brackets with PWM4x8 screws. (E-C)
9. The installation completion diagram is as follows. (F-A)