

4" Wide Housing

Product Features

Edgeline series architectural linear luminaire housing from 4" wide aluminum extruded profile, available in 2, 4 and 8-Ft length with Black, White finish; aircraft steel cable suspension system for direct ceiling mounting, with power supply unit integral inside fixture, and power feed cable through junction box cover plate; integral driver, frosted polycarbonate lens; emits even soft direct, direct/indirect facing light for general illumination; >90CRI LED; field selectable CCT in 2700K / 3000K / 3500K / 4000K / 5000K; 70% of luminous flux after 100,000 hours; cULus damp location listed; universal input 120-277V power supply with 0-10V dimming and a 0-100% dimming range. Tunable White and Dim-to-Warm options available.

Technical Specifications

INPUT VOLTAGE	Universal Input AC120-277V
FREQUENCY	50/60hz
COLOR TEMPERATURE	Field Selectable 2700K / 3000K / 3500K / 4000K / 5000K, Dim-to-Warm, Tunable White
COLOR RENDERING INDEX	>90
DISTRIBUTION	Direct/Indirect Ratio Field Selectable 100%, 70%/30%, 50%/50%, 30%/70%, 100%
IP RATING	Damp Location
LIFE SPAN	>100,000 Hours
DIMMING	0-10V Dimming with 0-100% Dimming Range



EDGE LINE SERIES | EDGE LINE 4"

SUBMITTAL WORKSHEET

Order Code Example: EGL4 - L2 - 9SC - BK - GD - UD - EMB-8W-B
 A B C D E F G

A SERIES (CHOOSE ONE)

EGL4 Edgeline Series 4" Profile Architectural Linear

B SIZE & OUTPUT (CHOOSE ONE)

CODE	LENGTH	DISTRIBUTION	DIRECT/INDIRECT RATIO	FIELD SELECTABLE	POWER & LUMEN FIELD SELECTABLE
IL2 QS	2FT	100%, 70%/30%, 50%/50%, 30%/70%, 100%			12.5W / 19W / 25W
IL4 QS	4FT	100%, 70%/30%, 50%/50%, 30%/70%, 100%			25W / 37.5W / 50W
IL8 QS	8FT	100%, 70%/30%, 50%/50%, 30%/70%, 100%			50W / 75W / 100W

C CCT (CHOOSE ONE)

9SC **QS** Field Selectable 2700K / 3000K / 3500K / 4000K / 5000K

D FINISH (CHOOSE ONE)

BK **QS** Black
 WH **QS** White

E DECORATIVE REFLECTOR (CHOOSE ONE - OPTIONAL)

BK **QS** Black
 GD **QS** Gold
 RG **QS** Rose Gold
 SV **QS** Silver
 WH **QS** White



F INPUT (CHOOSE ONE)

UD **QS** 120-277V, 0-10V Dimming
 DW **QS** 120-277V, 0-10V Dim-to-Warm Dimming
 TW **QS** 120-277V, 0-10V Tunable White Dimming

G OPTIONS

BAA Assembled in America, Compliant with BAA (COTS)
 LENS-EGL-40 **QS** Continuous Diffuser Rolling Lens Up to 40FT.
 SENSOR-KIT-IFS06R **QS** Integral PIR on/off/dimming/photosensing (14V DC Power by Driver)
 EMB-8W-B* **QS** 90-Minute Self-Diagnostic Emergency Battery 8W 100-347VAC Input 170VDC Output

*see page 7 for EMB and sensor spec

EDGE LINE SERIES | EDGE LINE 4"

SUBMITTAL WORKSHEET

Order Code Example: EGL-QM - EGL-L-CON
H I

H MOUNTING (CHOOSE ONE)

- EGL-QM **QS** Quick Mount
- EGL-QMT **QS** Quick Mount for T-Grid Ceiling
- EGL-WM **QS** Wall Mount

*see page 3 for detail

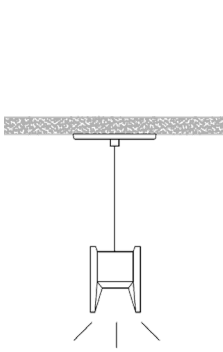

EGL-QM
Quick Mount

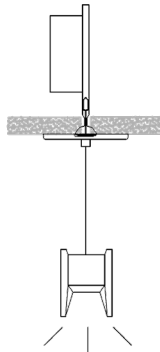

EGL-QMT
Quick Mount
for T-Grid Ceiling

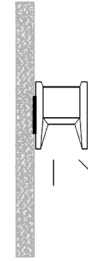

EGL-WM
Wall Mount

I CONNECTORS

- EGL4-CON Edgeline Profile Inline Joiner (metal bracket)
- EGL4-L-CON Edgeline Profile "L" 90° Connector
- EGL4-X-CON Edgeline Profile "X" 90° Connector
- EGL4-Y-CON Edgeline Profile "Y" 120° Connector

*see page 7 for EMB and sensor spec

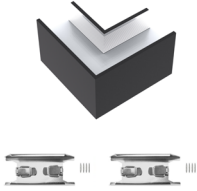
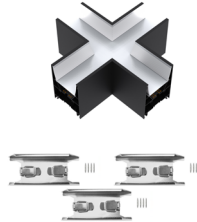
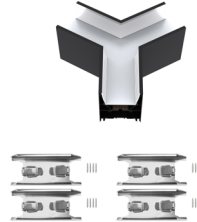
EGL4-CON EGL Profile Inline Joiner	EGL4-L-CON EGL Profile "L" 90° Connector	EGL4-X-CON EGL Profile "X" 90° Connector	EGL4-Y-CON EGL Profile "Y" 90° Connector
			

EDGE LINE SERIES | EDGE LINE 4"

DIMENSIONS

Size	L	EGL2.4		EGL4	
		W	H	W	H
2FT	26.14"	2.4"	4"	3.98"	5.22"
4FT	49.76"				
8FT	97.01"				

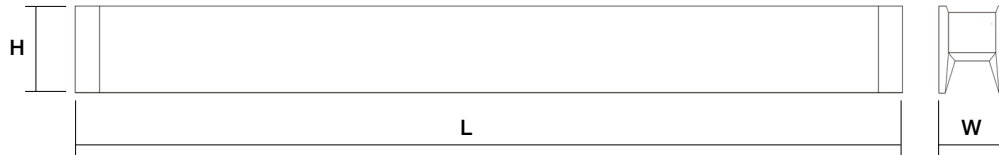

OUTPUT

Selectable CCT

2700K, 3000K, 3500K, 4000K, 5000K

90+ CRI 

Selectable Wattage



Lv1



Lv2



Lv3

Selectable Light Distribution

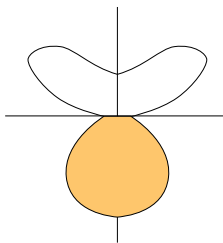

100% Direct

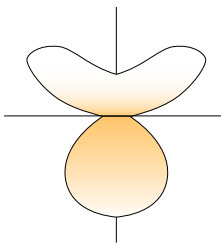

30% Indirect
70% Direct

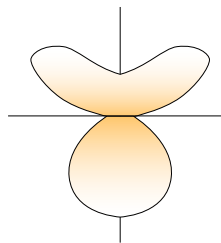

50% Indirect
50% Direct

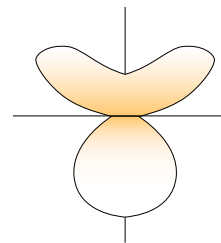

70% Indirect
30% Direct

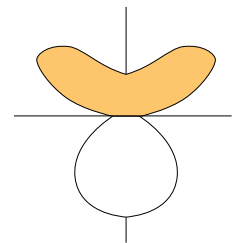

100% Indirect

EDGE LINE SERIES | EDGE LINE 4"

PERFORMANCE DATA

		2700K (90CRI)	3000K (90CRI)	3500K (90CRI)	4000K (90CRI)	5000K (90CRI)
EGL4	Lumens Per Foot	1500	1500	1550	1550	1550
	Input Wattage Per Foot	12.5W	12.5	12.5W	12.5W	12.5W
	Efficacy	120 lm/W	120 lm/W	125 lm/W	125 lm/W	125 lm/W

ELECTRICAL DATA

NUMBER OF DRIVERS	DRIVER CURRENT (mA)	EDGE LINE 4"		
		Nominal Power (W)	INPUT VOLTAGE (V)	CURRENT (AMPS)
1	525	25	120	0.21
		25	208	0.12
		25	240	0.10
		25	277	0.09
1	1050	50	120	0.42
		50	208	0.24
		50	240	0.21
		50	277	0.18
1	2100	100	120	0.83
		100	208	0.48
		100	240	0.42
		100	277	0.36

EDGE LINE SERIES | EDGE LINE 4"

PHOTOMETRIC

IES: EGL4-9SC @ 5000K 50W D-100%

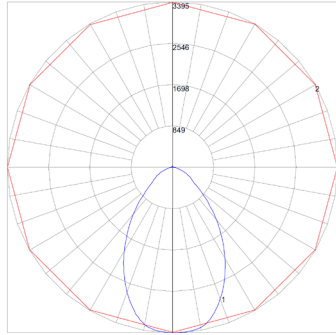

Zone	Lumen	Luminaire%
0-30	2449	37.80
0-40	3747	57.90
0-60	5643	87.20
0-90	6403	98.90
0-180	6472	100

Lumen: 6472
Input Watts: 49.53 W
Efficacy: 131 LPW

IES: EGL4-9SC @ 2700K 50W D-100%

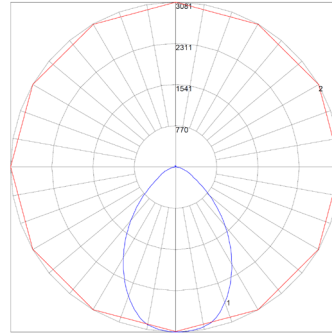

Zone	Lumen	Luminaire%
0-30	2222	37.90
0-40	3398	58.00
0-60	5113	87.20
0-90	5800	98.90
0-180	5863	100

Lumen: 5863
Input Watts: 49.53 W
Efficacy: 118 LPW

IES: EGL4-9SC @ 3500K 50W D-70% I-30%

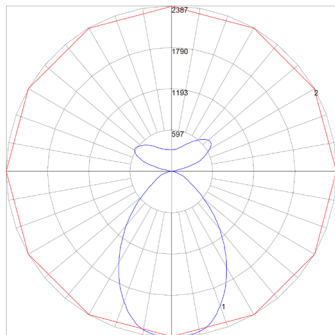

Zone	Lumen	Luminaire%
0-30	1723	27.20
0-40	2636	41.60
0-60	3972	62.70
0-90	4515	71.30
0-180	6334	100

Lumen: 6334
Input Watts: 50.69 W
Efficacy: 125 LPW

EDGE LINE SERIES | EDGE LINE 4"

EMB SPEC

Model	Battery Capacity	Input	Output	Output Power	Operating Temp	Installation
EMB-8W-B	90mins	100-347VAC	170VDC	8W	0°C ~ 50°C 32°F ~ 122°F	Factory or Field Install
EMB-18W-B	90mins	100-347VAC	170VDC	18W	0°C ~ 50°C 32°F ~ 122°F	Factory or Field Install

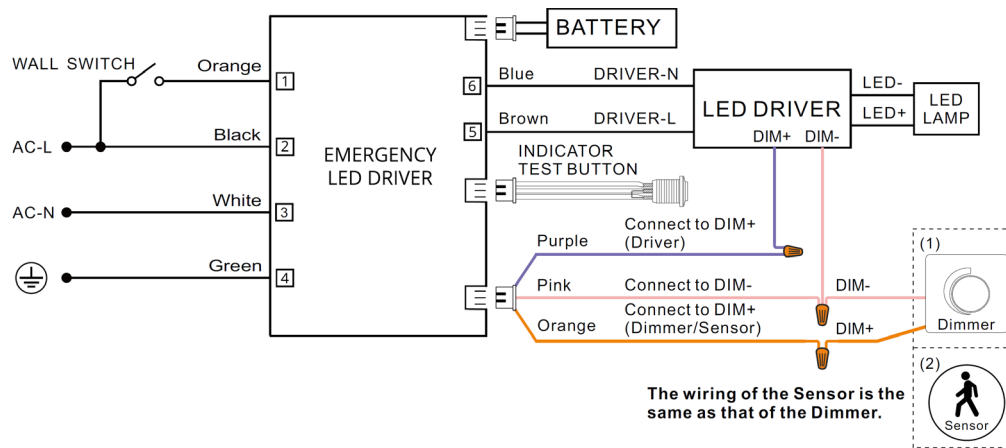

SENSOR SPEC

Model	Type	Mounting	Coverage	Input	Function	Programmable
SENSOR-KIT-IFS06R	PIR Sensor	Integral to Fixture	-	14V DC	On/Off Daylight Harvesting Bi-Level Dimming Adj. Hold Time	-

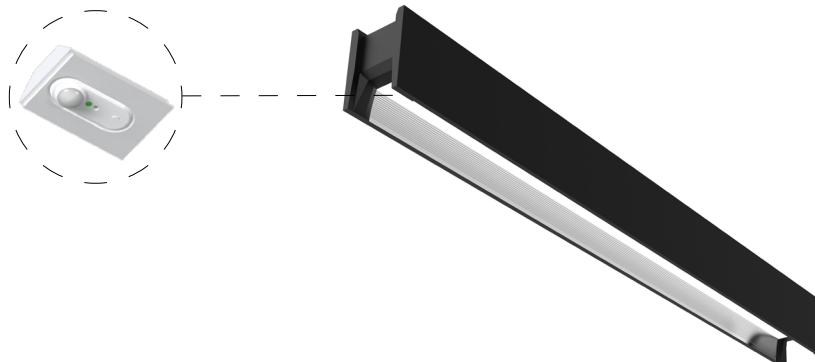

SENSOR-KIT-IFS06R PIR SENSOR

FEATURE

- **Installation:** Factory Install - Sensor Integral to Fixture
- **Commissioning:** through Remote Control
- **Control:** Adjustable Hold Time, Bi-Level Dimming, Manual/Auto - On/Off
- **Sensor:** Motion (Occupancy/Vacancy/Manual) and Daylight Harvesting



SPECIFICATIONS

SENSOR TYPE:	Passive Infrared Sensor (PIR)	COMMISSIONING RANGE:	50FT from Remote Control
INPUT VOLTAGE:	10-14VDC, >50mA	TIME SETTING:	10sec ~ 60min (adjustable)
LIGHT-CONTROL:	Daylight Harvesting with Automatic Dimming	DETECTION ANGLE:	360°
CONTROL OUTPUT:	0-10V, Max. 25mA sinking current	MOUNTING HEIGHT:	12FT Max.
OPERATING TEMP:	-4°F ~ +140°F (-20°C ~ +60°C)	WARRANTY:	5 years
		IP RATING:	IP20

DIMENSIONS

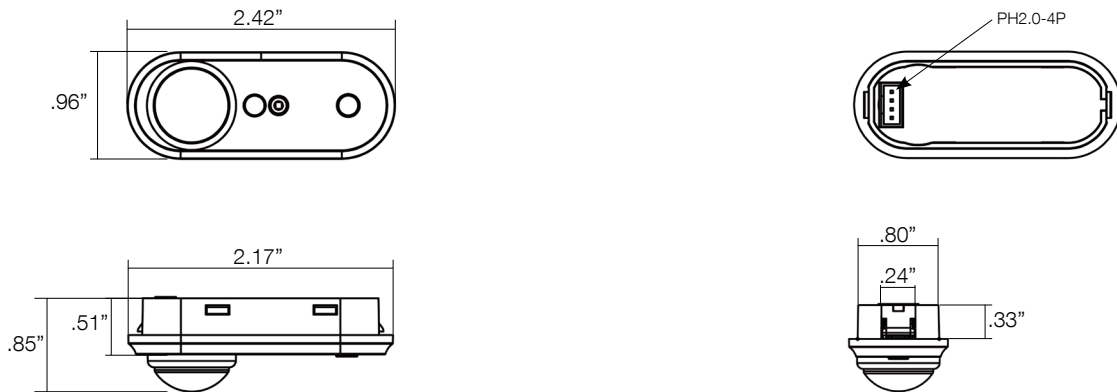

COVERAGE PATTERNS

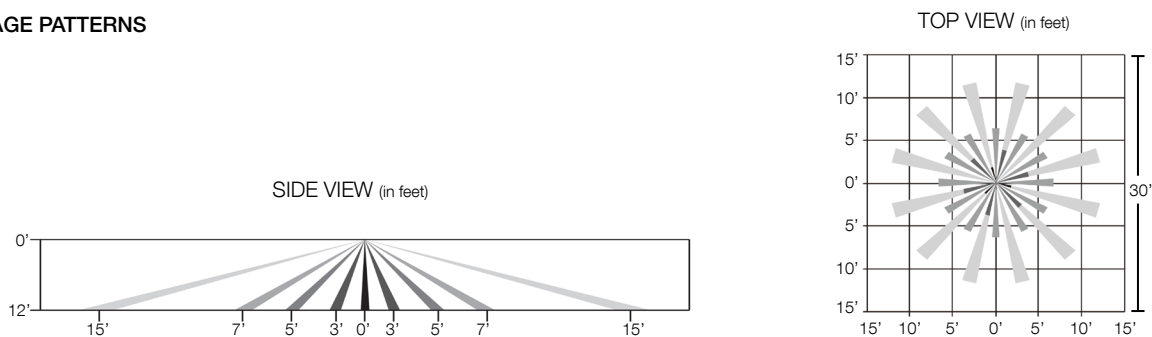

ORDER CODE

EXAMPLE: SENSOR-IFS06R

A

SERIES

SENSOR-KIT-IFS06R Integral PIR on/off/dimming/photosensing (14V DC Power by Driver)

EDGE LINE SERIES | EDGE LINE 4"

INSTALLATION

QM - Quick Mount Installation

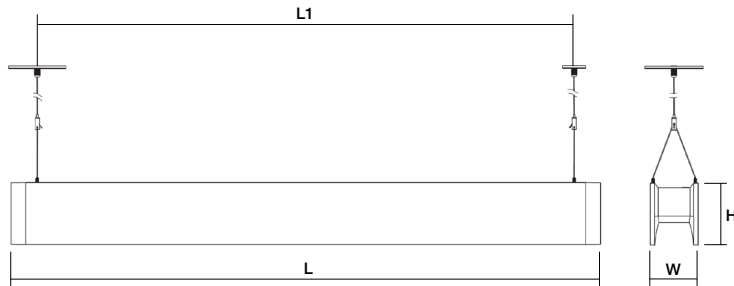

EGL4				
Size	L	W	H	L1 - Installation Spacing
2FT	26.14"	4"	5.22"	19.68"
4FT	49.76"			43.30"
8FT	97.01"			90.55"

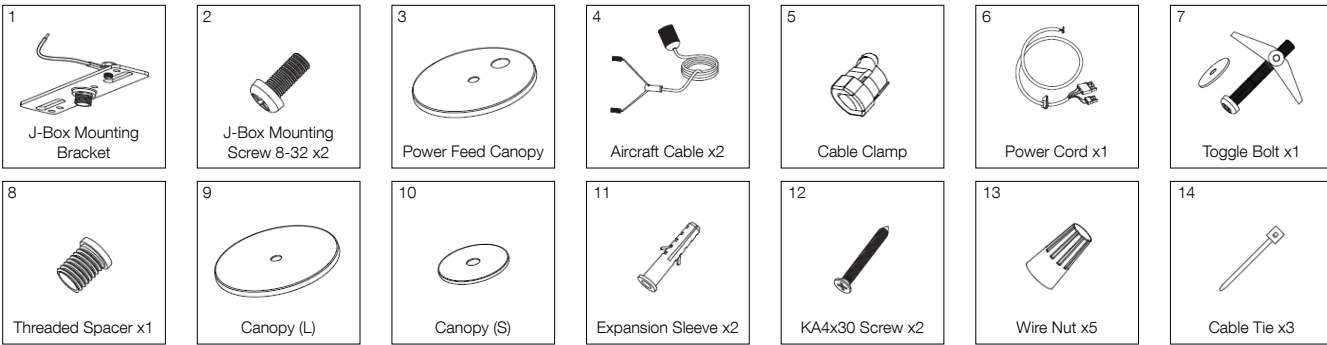

1

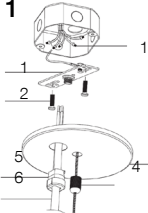

Secure the mounting bracket to the J-box with two 8-32 screws. Route the power cord through the cable clamp, make wire-nut connections per the wiring diagram, tuck wires into the J-box, then attach the canopy and tighten the aircraft cable lock nut onto the threaded spacer.

2

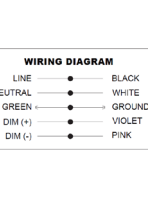

Mark the position of the canopy, secure the threaded spacer to the ceiling with a toggle bolt or expansion anchor, feed the canopy through the spacer, then tighten the lock nut of the aircraft cable onto the exposed threaded spacer.

3

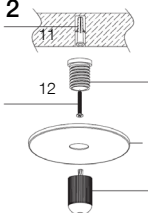

Loosen the screws and remove the endcap from the power feed side of the luminaire.

4

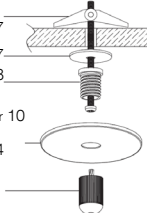

Fix the branched ends of the aircraft cables to the threaded rods at both sides of the luminaire body.

5

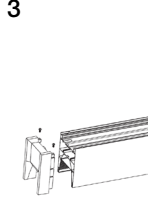

Knock out the knockout hole. Align and mate the terminals of the power cord with those of the luminaire body, and clip the SR cable clip of the power cord into the U-shaped groove.

6

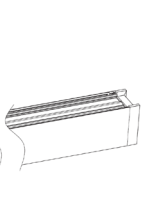

Tuck the wires into the luminaire body and reinstall the endcap.

7

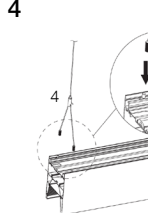

Installation Completion Diagram.

EDGE LINE SERIES | EDGE LINE 4"

INSTALLATION

QMT - T-Grid Quick Mount Installation

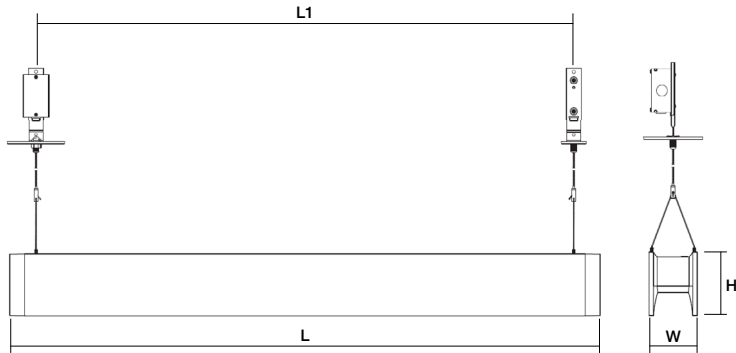

EGL4				
Size	L	W	H	L1 - Installation Spacing
2FT	26.14"	4"	5.22"	19.68"
4FT	49.76"			43.30"
8FT	97.01"			90.55"

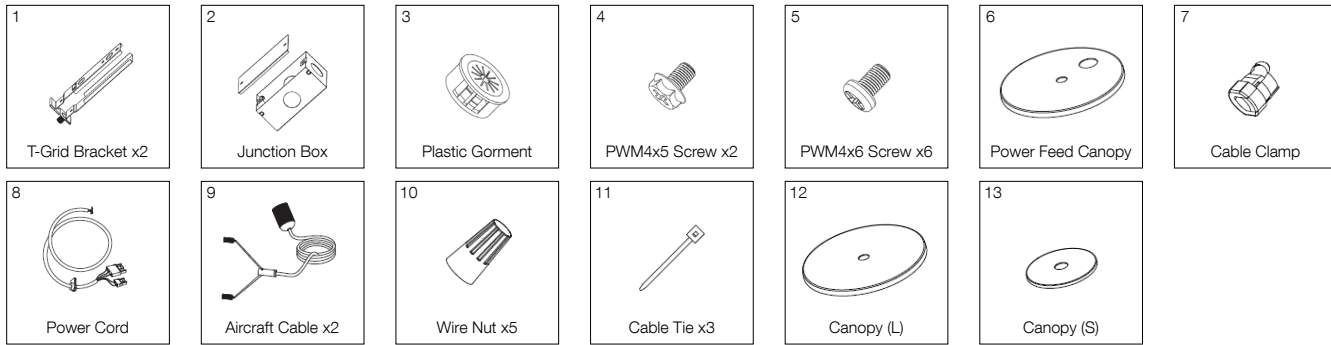

1

Assemble the T-Grid bracket with two PM4x6 screws. Install the grommet, secure the J-Box to the bracket, route the power cord through the clamp and power feed canopy, and make wire-nut connections inside the J-Box. Attach the canopy and tighten the aircraft cable lock nut, then secure the J-Box cover.

2

Install the canopy (12 or 13) and aircraft cable onto the assembled T-Grid bracket as shown.

3

Clip the brackets into the t-grid ceiling

4

Loosen the screws and remove the endcap from the power feed side of the luminaire.

5

Fix the branched ends of the aircraft cables to the threaded rods at both sides of the luminaire body.

6

Knock out the knockout hole. Align and mate the terminals of the power cord with those of the luminaire body, and clip the SR cable clip of the power cord into the U-shaped groove.

7

Tuck the wires into the luminaire body and reinstall the endcap to complete installation.







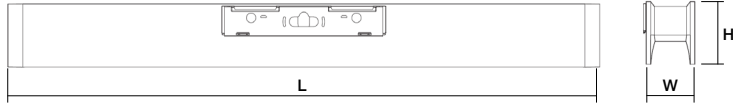

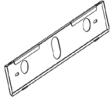

EDGE LINE SERIES | EDGE LINE 4"



INSTALLATION

WM - Wall Mount Installation

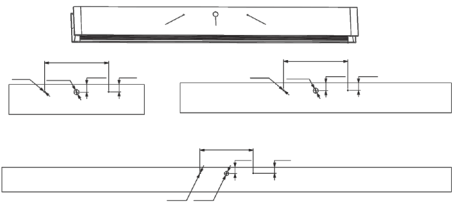
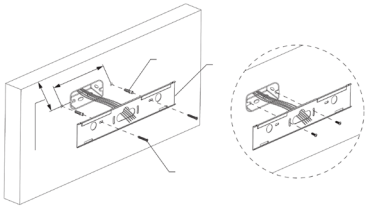
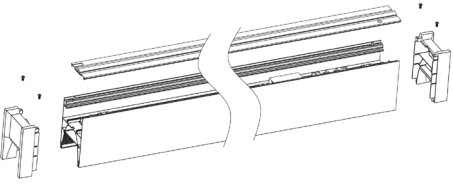
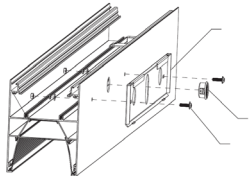
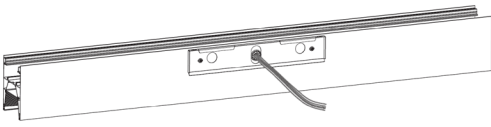
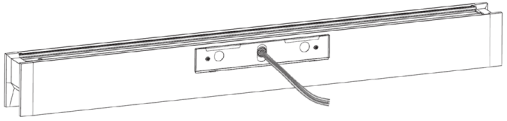
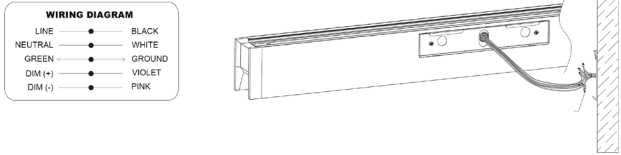

EGL4			
Size	L	W	H
2FT	26.14"	4"	5.22"
4FT	49.76"		
8FT	97.01"		

- | | | | | | | | |
|--|---|---|--|---|--|--|--|
| 1

Wall Mount Bracket | 2

Fixture Bracket | 3

Expansion Sleeve x2 | 4

KA4x30 Screw x2 | 5

6#-32x5/16 Screw x2 | 6

J-Box Mounting Screw 8-32 x2 | 7

PM3x8 Screw x2 | |
| 8

Plastic Grommet | 9

J-Box Cover | 10

Wire Nut x5 | 11

PWM4x14 Screw Assembly x2 | | | | |

<p>1</p>  <p>Machine the holes on the luminaire body in accordance with their dimensions and the details specified in the drawing.</p>	<p>2</p>  <p>Method A: Drill holes, insert the expansion sleeves, feed the wires through the central hole of the wall-mounting bracket, and secure the bracket with KA4x30 screws. Method B: Feed the wires through the central hole of the wall-mounting bracket and secure the bracket with 6#-32x5/16 screws.</p>															
<p>3</p>  <p>Remove the endcaps from both ends of the luminaire, as well as the top cover.</p>	<p>4</p>  <p>Secure the fixture bracket to the mounting holes on the luminaire body with PWM4x14 screw assemblies. Insert the plastic grommet into the wire-passing hole.</p>															
<p>5</p>  <p>Cut the wires inside the luminaire body, then feed them through the plastic grommet.</p>	<p>6</p>  <p>Reinstall the endcaps and top cover.</p>															
<p>7</p>  <p>WIRING DIAGRAM</p> <table border="0"> <tr> <td>LINE</td> <td>●</td> <td>BLACK</td> </tr> <tr> <td>NEUTRAL</td> <td>●</td> <td>WHITE</td> </tr> <tr> <td>GREEN</td> <td>●</td> <td>GROUND</td> </tr> <tr> <td>DIM (+)</td> <td>●</td> <td>VIOLET</td> </tr> <tr> <td>DIM (-)</td> <td>●</td> <td>PINK</td> </tr> </table> <p>Connect the wires of the luminaire to the mains supply with the wire nuts.</p>	LINE	●	BLACK	NEUTRAL	●	WHITE	GREEN	●	GROUND	DIM (+)	●	VIOLET	DIM (-)	●	PINK	<p>8</p>  <p>Hang the luminaire (with its fixture bracket pre-attached) onto the wall-mounting bracket. Secure the two brackets with the PM3x8 screws to complete installation.</p>
LINE	●	BLACK														
NEUTRAL	●	WHITE														
GREEN	●	GROUND														
DIM (+)	●	VIOLET														
DIM (-)	●	PINK														